

Event & Party Layout

12' x 40' / 3.7m x 12.2m Frame Tent

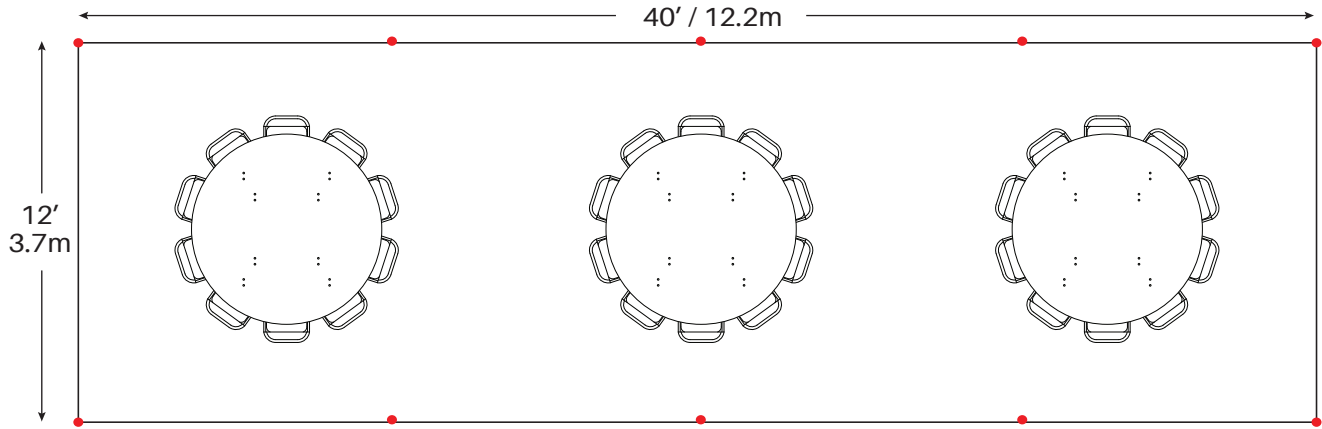

3 - 72" Round Tables
30 - Chairs

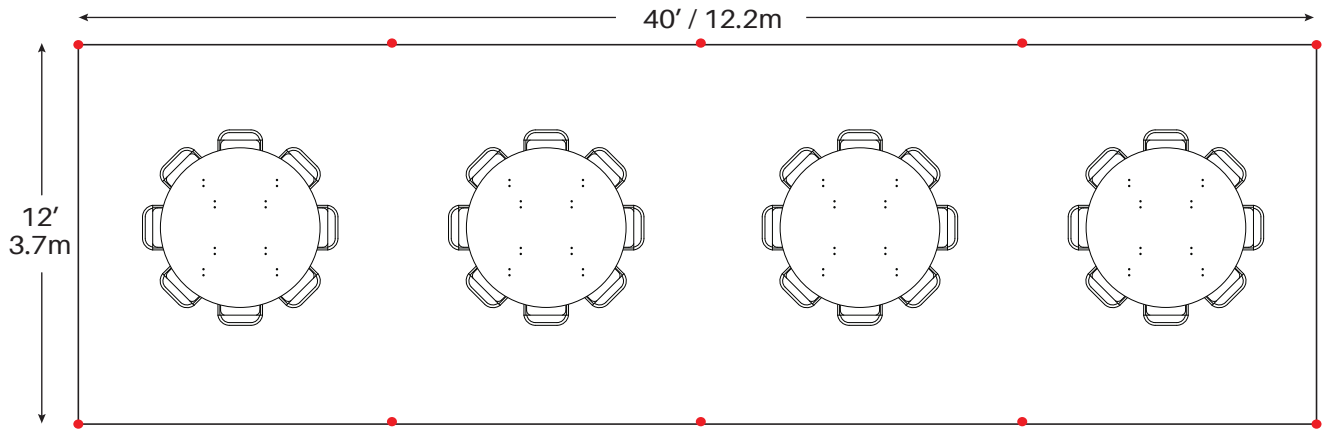

4 - 60" Round Tables
32 - Chairs

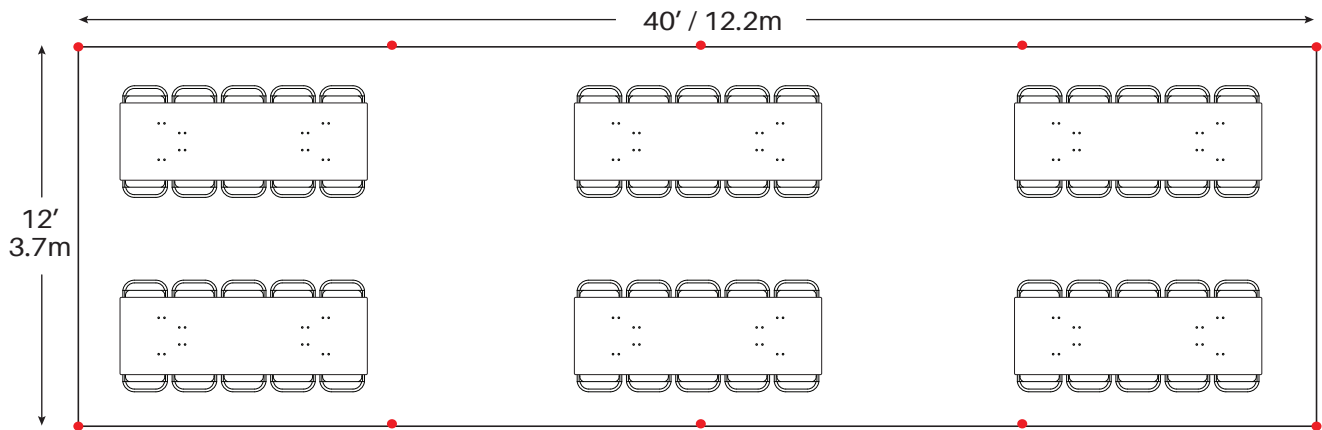

6 - 8' Banquet Tables
60 - Chairs

● = Legs

Minimum Seating Layouts

Event & Party Layout

12' x 40' / 3.7m x 12.2m Frame Tent

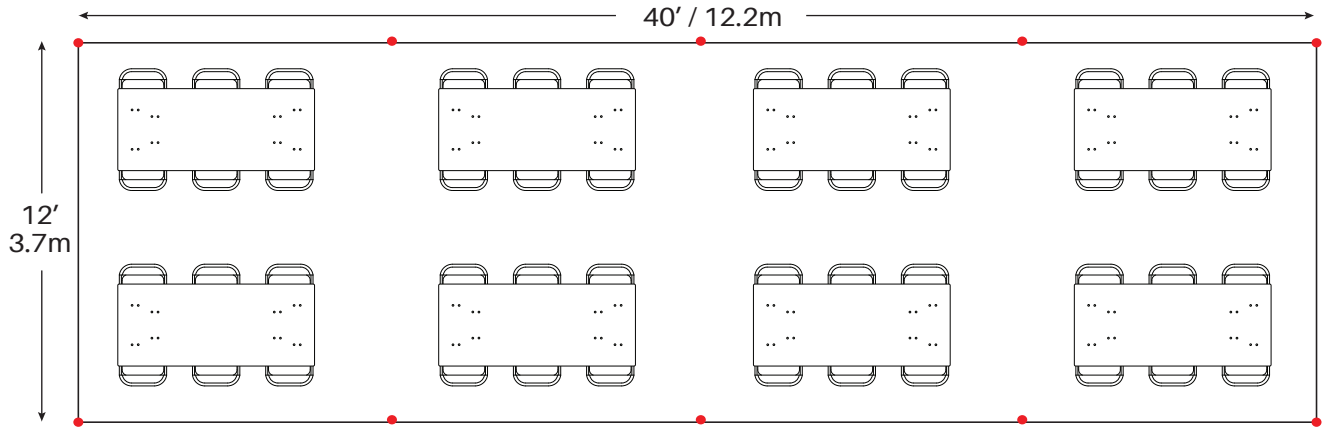

8 - 6' Banquet Tables
48- Chairs

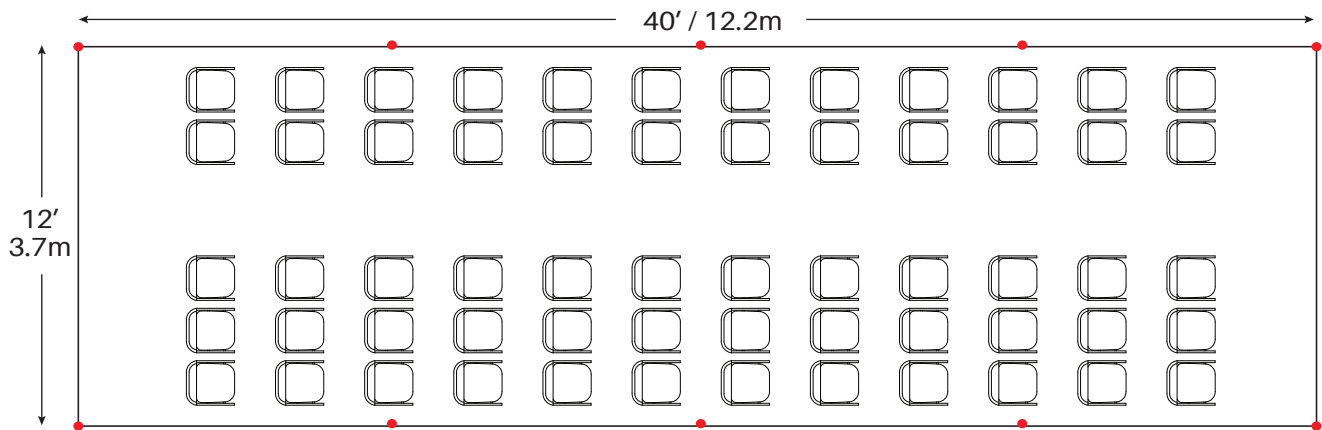

Cathedral Seating - 60 Chairs

● = Legs

Minimum Seating Layouts