

72" Round Folding Table (Replacement) Legs

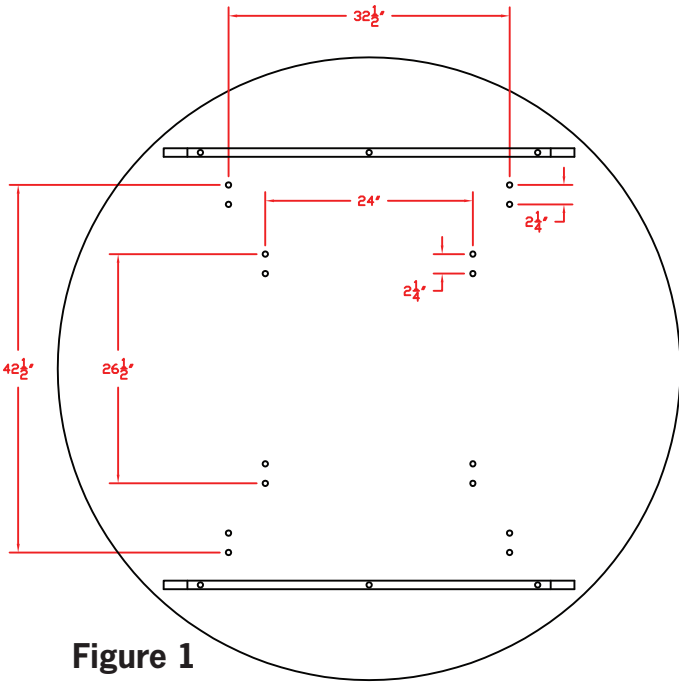

Figure 1

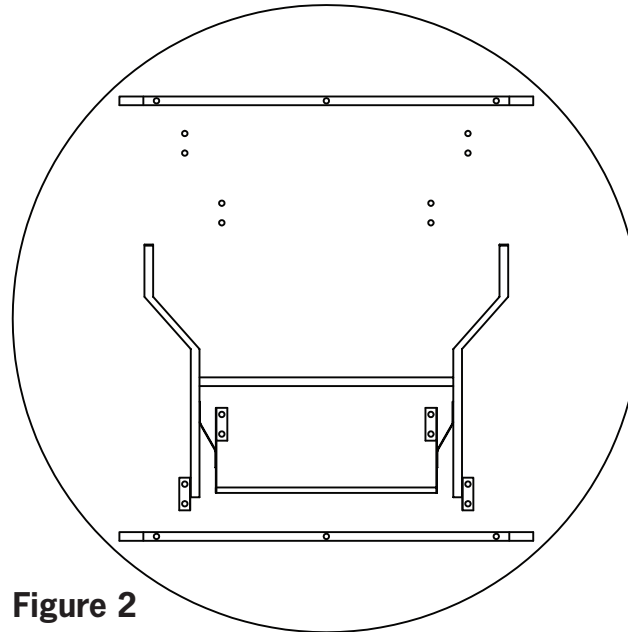

Figure 2

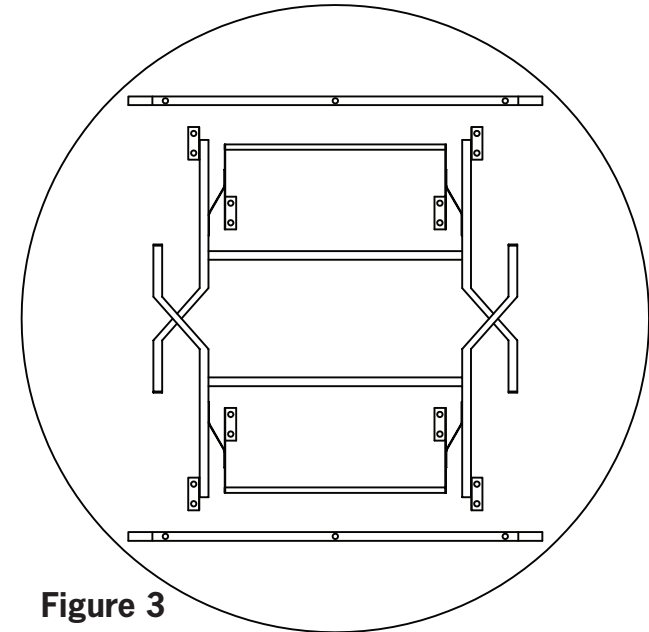

Figure 3

Replacement Table Legs:

The replacement legs should be centered on the table and spread apart from each other the distance listed on figure 1.

To ensure accuracy; please lay replacement legs on the table to use as a template.

Replacement legs are counter sunk bolted directly to the table.



A Division of **CELINA TENT**