

12' x 24' CLASSIC SERIES GABLE FRAME TENT 1 PC. PRODUCT MANUAL

ver.20170613



Read this manual before using this product. Failure to do so can result in serious injury.

SAVE THIS MANUAL

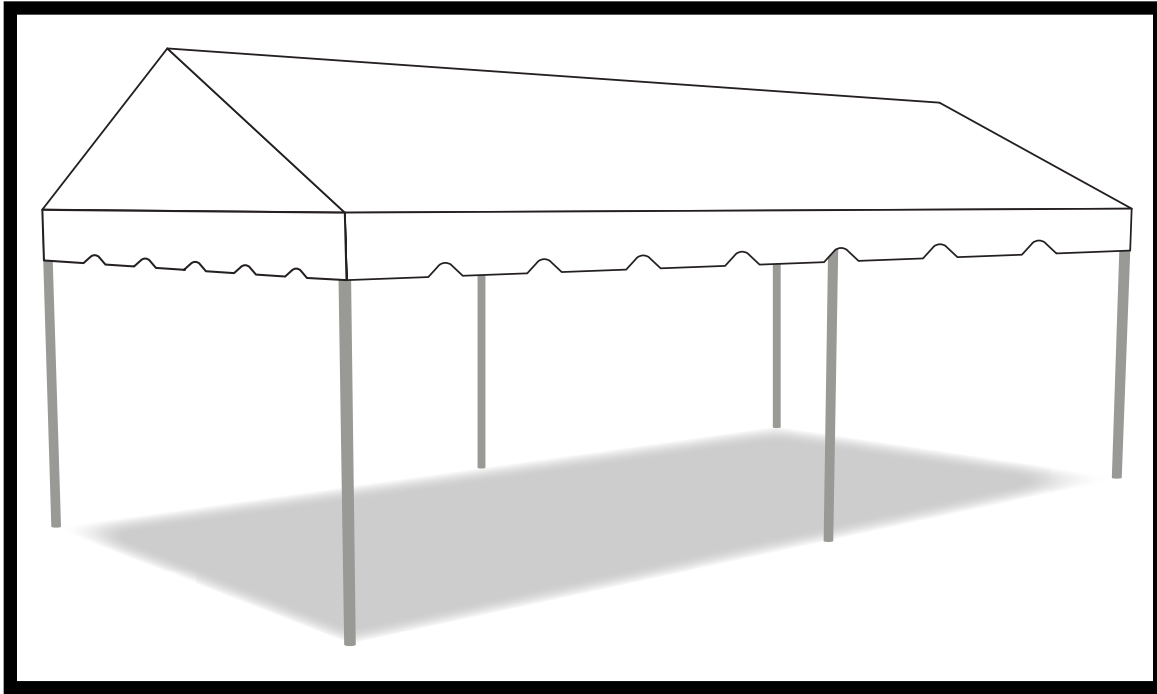

NOTICE

The warnings, cautions, and instructions discussed in this instruction manual cannot cover all possible conditions and situations that may occur. It must be understood by the user that common sense and caution are factors which cannot be built into this product, but must be supplied by the installer and/or user.

Tent, canopy, structure, and shelter products are manufactured for use as temporary structures and do not meet structural code unless specified. Since weather is unpredictable, the installer/end user must incorporate their own good judgment, common sense and knowledge of local conditions with the installation instruction guidelines. The installer is responsible for anticipating weather severity for proper time and method of installation.

WARNING SYMBOLS AND DEFINITIONS

| | |
|-----------------|--|
| | This is the safety alert symbol. It is used to alert you to potential personal injury hazards. Obey all safety messages that follow this symbol to avoid possible injury or death. |
| ▲WARNING | Indicates a hazardous situation which, if not avoided, could result in death or serious injury. |
| ▲CAUTION | Indicates a hazardous situation which, if not avoided, could result in minor or moderate injury. |

Description



12' x 24' Classic Series Gable Frame Tent, 1 Piece

Classic Series Gable Frame tents are a slight alternative to the Classic Frame tent by providing a gable at each end. Gable Frame tents are ideal for situations requiring the tent to be installed as an extension to a building, used to cover a walk way, or connecting two separated buildings or structures. The Gable ends help eliminate water runoff that a standard tent would have allow at the entry of a tent. The Gable Frame tent has a stylish scalloped valance providing its traditional appearance.

Suggested Equipment

Drop cloth or ground cloth, sledge hammer, or electric / gas breaker hammer fitted with stake driver bit, stake puller, and frame tent jack/ lift.

Colors available by special order

- White & Red (5051)
- White & Green (5052)
- White & Blue (5053)

Classic Series Gable Frame Tent Specifications

| | | |
|----------------------------|---|--------------------|
| Width | 12 ft. /3.7m | |
| Length | 24 ft. /7.3m | |
| Area | 288 ft ² /27.0m ² | |
| Eave Height | 7' / 2.1m | 8' / 2.4m |
| Overall Height | 10' / 3.1m | 11' / 3.4m |
| Pitch | 3' / 0.9m | |
| Complete Weight Aluminum | 372 Lbs. / 169 Kg. | 378 Lbs. / 171 Kg. |
| Complete Weight Galvanized | 430 Lbs. / 195 Kg. | 439 Lbs. / 199 Kg. |
| Series / Brand | Classic | |
| Class | Frame | |
| Center Pole | No | |
| Style / Shape | Gable | |
| Expandable | No | |
| Custom Printing Available | Yes | |
| Fabric Material | PVC Coated Polyester | |
| Fabric Material Weight | 16 oz. / yd ² / 540 gsm | |
| Fabric Translucency | Blockout | |
| Water Repellency | Waterproof | |
| Flame Resistant | Yes | |
| UV Resistant | Yes | |
| Mold and Mildew Resistant | Yes | |
| Frame / Pole Material | Aluminum OR Galvanized | |
| Longest Component Alum. | 11'4" / 3.5m | |
| Persons required for setup | 2-4 | |
| Occupancy | 29 Sit Down Dinner - 48 Cathedral Seating | |

SAFETY

INSTALLATION

MAINTENANCE

CONTACTS

PERSONAL SAFETY



STAY ALERT: Watch what you are doing, and use common sense when installing/striking a tent, canopy, structure, or shelter. Do not setup/strike while under the influence of drugs, alcohol, or medication. A moment of inattention may result in serious personal injury.



DO NOT OVER LIFT: The equipment may be heavy and may require 2 or more people to lift and move.



DO NOT OVERREACH: Keep proper footing and balance at all times. Use a ladder when necessary.



DRESS PROPERLY: Do not wear loose clothing or jewelry. Contain long hair. Keep hair, clothing, and hands/gloves away from power equipment and snag or pinch points.



USE SAFETY EQUIPMENT: Eye protection, safety shoes, hard hats, or hearing protection must be used for appropriate conditions.

WEATHER

Since weather is unpredictable, the installer/end user must incorporate their own judgment, common sense and knowledge of local conditions with the installation instruction guidelines. The installer is responsible for anticipating weather severity for proper time and method of installation.

- **Rain:** **⚠️WARNING** Rain water can collect on the tent fabric and cause 'ponding' or 'water pocketing' under certain weather conditions, especially if the tent is not installed and tensioned correctly. The additional weight from the water will cause the tent to sag and ponding will continue to get worse. The weight can destroy the tent fabric and/or cause the poles and baseplates to sink into the soil. Highly saturated soil will cause the stakes to lose their holding power.
- **Wind:** **⚠️WARNING** Wind or wind and rain can cause the tension of the tent to change by loosening ratchet assemblies, pulling stakes, and or causing the poles to shift or sink. It is very important to do routine maintenance checks and maintain proper tension on the tent top at all times especially if weather conditions are such that ratchets are beginning to loosen.
- **Lightning:** **⚠️WARNING** Immediately evacuate the tent until the chance of a lightning strike is no longer present.
- **Snow:** Tents, canopies, structures, and shelters are not designed to carry any type of snow loading. These products should not be used if snow of any kind is present, and must be evacuated immediately.

SITE SELECTION

Site selection is extremely important. The installer must adhere to local building codes and fire regulations. The installer must evaluate each installation site and determine the proper securing and anchoring method and device appropriate for the conditions. Some soils require different staking or securing methods than what may be/have been purchased with the standard tent package. Celina Tent's instructions, YouTube videos, and Layout Handbook summarize all the functions of each product, the rules for using them and suggestions for their use. However, field situations, site conditions, weather and local experience may mandate other methods. Review the following conditions at the proposed site and plan accordingly.

The best site qualities are:

- **Location:** Elevated, level, and clear of debris
- **Soil Conditions:** Adequate for stable anchoring
- **Space:** Adequate space for the perimeter and stake lines
- **Surface Type:** Grass, Gravel, Concrete, Asphalt, Wood
- **Site Access:** Materials and services can easily be delivered to the site

⚠️WARNING Also allow for:

- **Overhead Obstructions:** Electrical/telephone lines, tree branches
- **Underground Utilities:** Electric, Gas, Oil, Steam, Telephone, CATV, Water, Sewer
- **Weather Effects:** Monitor for extreme weather conditions and evacuate if necessary
- **Emergency Exit Capabilities:** Provide evacuation routes in case of a fire or bad weather

Before You Stake

By law you are required to contact your local “Call before you dig” number before you plan to dig or drive tent stakes / anchors. After calling, your local utility companies will mark the location of all underground utility lines. Laws from state to state vary on how far in advance you must call. Planning ahead and checking with your state’s program is always a smart idea. Failure to obtain a utility line location before digging can result in a substantial fine or serious injury. Please find your local “call before your dig number” in the contacts section of this manual.

⚠WARNING Prior to staking, be sure that no underground utilities are present. Celina is not responsible for methods that installers may choose to erect and secure the tent, canopy, structure, or shelter to the site surface. Celina’s responsibility is limited to the manufacture of the tent parts and materials. It is the installer’s responsibility, not Celina’s, to determine the appropriate number of stakes to meet the necessary wind loads on the installation site.

⚠WARNING Soil and setup conditions can vary greatly between installation sites. It is the installer’s responsibility to be sure the staking is adequate for each site on each setup. Additional staking, tiebacks, and/or stake bars may be required in order to safely setup and secure the product.

⚠WARNING The number of stakes suggested in this manual routinely does not meet the relevant local codes of the installation site. The number of stakes included in the standard kit will, in most cases, keep the tent, canopy, structure, or shelter setup. Due to various soil conditions the standard staking kit may be inadequate to keep the tent secure in high winds and wet or threatening weather. Regardless of the number of stakes included in standard kits, Celina makes no representation or warranty as to whether this is sufficient to meet the requirements for your installation site(s).

Staking Basics

A properly driven stake will have 6” or less of the head exposed. The deeper that the stake is driven, the greater holding strength the stake will have. Anchoring stakes must be driven deep and vertical.

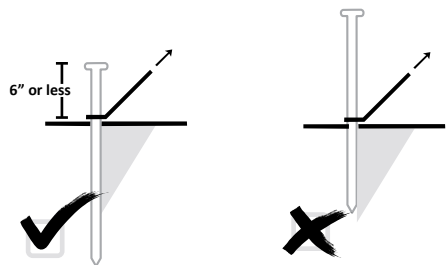

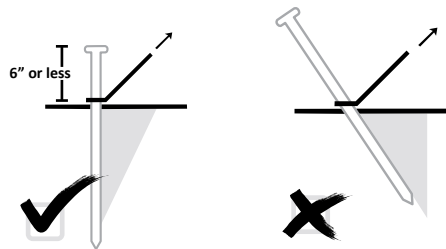

Stakes driven vertically have a greater holding strength than stakes driven at an angle. Vertically is defined as straight up down or angled up to 10° away from the tent, canopy, structure, or shelter.



For more information on staking and soil conditions, please view Celina Tent’s 15 part video series on YouTube.com or follow this link: Stake Pull Demonstration (1/15) www.goo.gl/v0XhV

REQUIRED HARDWARE

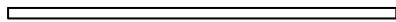
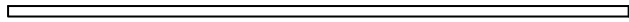
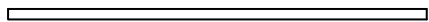
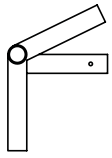
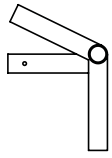
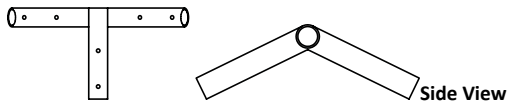
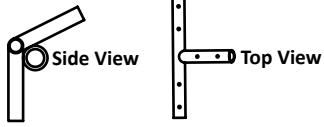
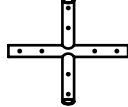
12' x 24' Classic Series Gable Frame Tent, 1 Piece

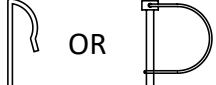
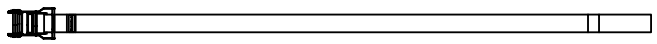
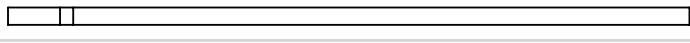
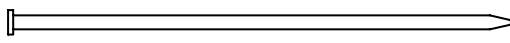
| Description (Key) | Size/ Color | Qty. | Picture |
|--|---------------------------|------|--|
| Rafter | 6'1" / Red | 6 |  |
| Spreader | 11'4" / White | 8 |  |
| Legs | 6'8"(7'8") / Brown(Black) | 6 |  |
| Gable Left Corner | | 2 |  |
| Gable Right Corner | | 2 |  |
| 3 Way Gable Crown | | 2 |  |
| Side Tee w/ Ring | | 2 |  |
| Ridge Crown | | 1 |  |
| Base Plate | | 6 |  |
| R Pin OR Pin & Bail | | 44 |  |
| A. Ratchet Buckle with Loop Strap | 2" Ratchet 5' Loop | 6 |  |
| B. Loop Strap | 8' Loop | 6 |  |
| Single Head Stakes | 36" | 6 |  |

NOTE: When the Ratchet Buckle with Loop Strap A is connected to Loop Strap B it forms the Ratchet Assembly.

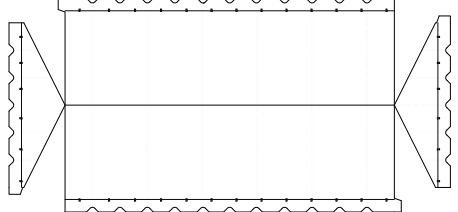
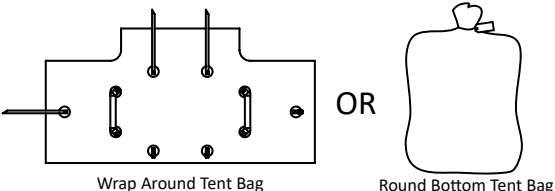
| | | | |
|----------|---------|-------|--|
| Tent Top | 12'x24' | 1 pc. |  |
| Tent Bag | B | 1 |  |

SAFETY

INSTALLATION

MAINTENANCE

CONTACTS

OPTIONAL ACCESSORIES

| | | | |
|-------------|-----|---|---------------------|
| Sidewall(s) | 20' | - | Sidewalls Available |
| Sidewall(s) | 30' | - | |

PARTS / MINIMUM STAKING LAYOUT

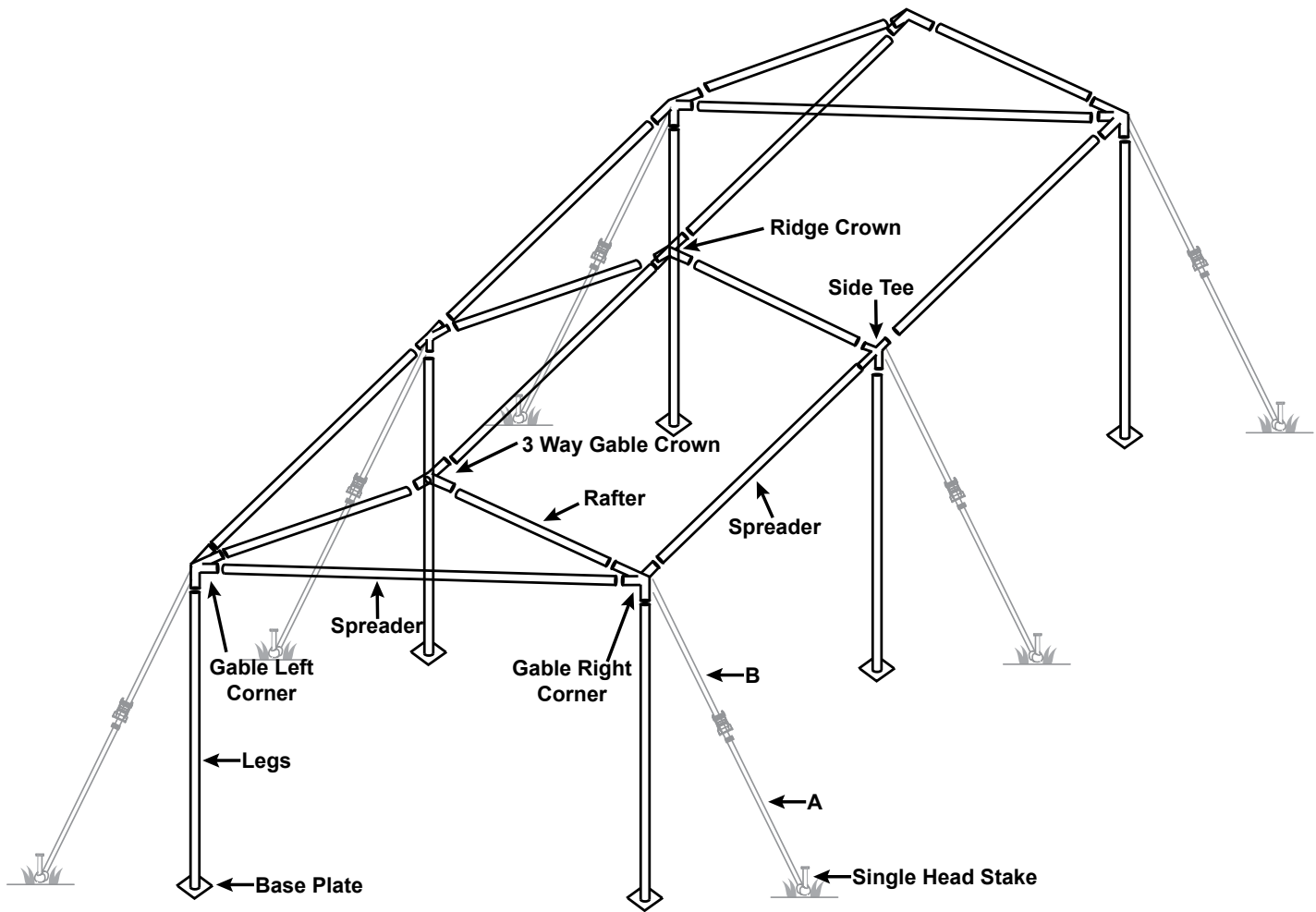
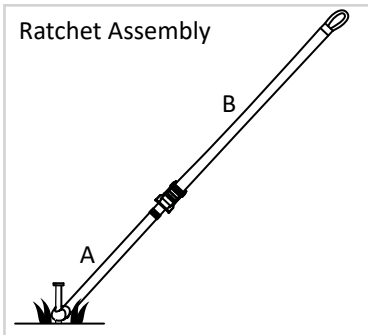

SAFETY

INSTALLATION

MAINTENANCE

CONTACTS

Set Up Instructions

1. Layout the frame parts on the ground in the approximate location that they will be when the frame is assembled. (See parts / minimum staking layout diagram)
2. Connect the 3 way gable crown to the rafters (6'1" red):
 - a. Each protrusion on the crown has two holes; one closer to the center (the alignment hole) and one further down the protrusion (the placement hole).
 - b. Place a pin in the alignment hole; this keeps the rafter from moving too far onto the crown. Slide the tubing onto the protrusion until it meets the pin.
 - c. Align the placement hole in the crown with the hole in the rafter and insert a pin.
 - d. Remove the alignment hole pin. (*This procedure applies to all frame fittings)
3. Connect the rest of the tubing in the following order:
 - a. First spreader (11'4" white) to first gable 3 way crown
 - b. Ridge crown to first spreader (11'4" white)
 - c. Rafters (6'1" red) to ridge crown
 - d. Second spreader (11'4" white) to ridge crown
 - e. Second spreader (11'4" white) to second gable 3 way crown
 - f. Rafters (6'1" red) to second gable crown
 - g. Side tee fittings to middle rafters (6'1" red)
 - h. Gable left and gable right corner fittings to corner rafters (6'1" red)
 - i. Spreaders (11'4" white) to side tee fittings and gable corner fittings
4. Fasten the loop strap (B) around the fitting at each leg location.



5. Roll out a drop cloth to protect the tent from dirt and abrasions next to the frame and unroll the tent top. Pull the tent top over the frame, lifting up on the fabric or "flapping" it to create a cushion of air.
6. Loosely fasten 2 alligator straps at each corner around the perimeter tubing to secure the tent top.

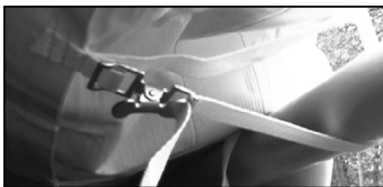

7. Attach the base plates to the legs (6'8" brown, or 7'8" black), securing with a pin.



8. In windy conditions, locate the downwind side of the tent to lift first; this keeps the wind from catching the tent.
9. Step on the base plate to free both hands and lift one side of the tent frame. Do not lift one corner at a time; lift the entire side of the tent. Insert corner fittings into the top of the leg, securing with a pin. Insert all pins from the outside in; this keeps the protruding section of the pin from puncturing the tent fabric.

10. While the tent is still low to the ground fasten the rest of the alligator straps around the perimeter tubing.



11. Repeat with the other side of the tent.

12. Center the tent top on the frame by hiding the seams behind the rafters and tightening the straps. Guide excess strap through the metal slide on the alligator clip.

13. Place stakes 5' out from each leg; drive stakes into the ground so that approximately 6" or less of the stake is showing.

14. Attach ratchet straps or ropes to the stakes (ratchet assemblies are standard on all Celina Classic Series Gable Frame Tents):

Ratchets: Attach the ratchet buckle with loop strap (A) to the stakes by turning the 6" loop at the end of the ratchet inside out and pull the strap through the loop to create a noose and pull tight over the stake. Take the loop strap (B) attached to the tent and pull it through the reel bars slot of the ratchet (ratchet buckle needs to have handle facing upward at all times) and pull the loop strap (B) back towards the tent approximately 1 ½ feet. Hold the strap at this point with one hand and begin to crank the ratchet handle back and forth.

Ropes: Attach the rope around the fitting at each leg location. Tie the bottom end of the rope to the stake using a Double Loop Clove Hitch Knot - Gripping the rope down from the grommet in your left hand, take the opposite end and create two loops that overlap. Move the first loop (located on the bottom) so that it slightly overlaps on top of the second; put loops over the stake through the center gap created by the overlapping loops. Pull tight with the excess rope.

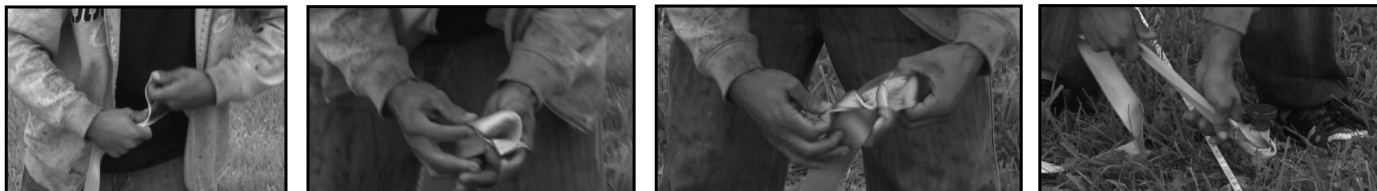

15. Roll excess ratchet straps and secure into the ratchet buckle.



16. The tent top should now be complete. If sidewalls are desired, unroll the sidewalls between the stakes and the legs around the perimeter of the tent. Starting at a leg, clip the sidewall snap hooks to the rope line that is attached to the tent top.

Sidewall Rope Tensioning: For new tents and during its life cycle, it may be necessary to tighten the sidewall support rope that runs the perimeter of the tent top. After the tent has been set up and tensioned, locate the corner where the sidewall rope starts and stops. Securely tie off one end of the rope. While pulling against the tie-off point, work your way around the perimeter of the tent, pulling out any unnecessary rope slack. Tie off the opposite end of the rope once reached.

Striking Instructions

1. Loosen all ratchet strap assemblies.
2. Unfasten all anchoring devices and alligator straps from the perimeter tubing (with the exception of 2 at each corner).
3. Remove 2 corner legs from one side and carefully set the tent frame on the ground.
4. Repeat with opposite side.
5. Unfasten the rest of the straps, completely disconnecting the tent top from the frame and stakes.
6. Roll out a drop cloth next to the frame.
7. Carefully remove the tent top from the frame, lifting up on the fabric or “flapping” it to create a cushion of air.
8. Fold and roll the tent top as tight as possible. Remember not to stand or walk on the tent top fabric.
9. Bagging (always use a drop cloth to protect the tent top from dirt and abrasions while bagging):
 - a. For Wrap-Around Tent Bag:
 - i. Lay the bag next to the tent top with the side-release buckles facing down. Roll the tent top onto the center of the bag.
 - ii. Connect the two short male and female side-release buckles; pull tight.
 - iii. Connect the remaining side-release buckle and pull tight.
 - b. For Round-Bottom Bag:
 - i. Place the folded tent top into the upright vertical position.
 - ii. Pull the round bottom tent bag over the upright tent top.
 - iii. Turn the tent top and bag over, pull the draw string tight and tie off.
10. Fold and roll up the drop cloth.
11. Disassemble all of the corner and center crown fittings by removing the pins and sliding the tubing off of the fittings. Work from the perimeter of the frame inward.
12. Remove all stakes.

FLAME RESISTANCE

Celina fabrics are inherently flame resistant. Open flames should never be used under any tent, canopy, structure, or shelter. Fabrics meet or exceed one or more of the following flammability specifications:

| | | |
|----------|----------------|-------------|
| NFPA-701 | CPAI-84 | ASTM D 6413 |
| BS 5438 | BS 7837 (1996) | DIN 4102-B1 |

TENT CARE

For maximum life of Celina fabrics, Celina recommends regular cleaning with the use of a soft brush with neutral soaps or cleaners, such as Celina Cleaning Products, Ivory dish soap, or warm water. Thorough rinsing and drying is required before storing the fabric.

Things that will cause premature degradation and may reduce life expectancy of a tent:

- Improper handling during installation/dismantling on rough surfaces will create pinholes and abrasions. ALWAYS USE A DROP CLOTH/GROUND CLOTH DURING INSTALLATION AND DISMANTLING.
- Walking on the fabric during installation/dismantling will create pinholes and abrasions.
- Extended use of the tent without cleaning
- Accumulation of dirt on the vinyl surface will promote the growth of mold and mildew and premature wear.
- Storage of vinyl that has not been dried thoroughly. Even a slightly damp product can promote the growth of mildew when folded and stored. Mold and mildew may require harsh cleaners to remove, which may cause premature wear. The best solution is to take every precaution to keep mold and mildew from growing in the first place. NEVER STORE A TENT, CANOPY, STRUCTURE, OR SHELTER IN A WET OR DAMP CONDITION.
- Harsh detergents and cleaners, which contain a solvent or bleach. The longer the exposure of PVC vinyl to these products, the more it will reduce the life of the PVC vinyl.
- High-abrasive cleaners, including wire brushes, power washers and/or commercial washing machines will result in premature wear and deterioration of tent fabrics.
- Wind whip – Loosely tensioned fabric that whips in the wind will damage over time.

Vinyl Repair

Celina's repair products provide an easy solution to tears, punctures, or holes. Repair kits and tools are available online at www.GetTent.com or by contacting Celina.

PRODUCT WARRANTY

Celina Tent Inc. warrants that this product will be free from defects in material and workmanship for a period of one (1) year following the date of purchase. Defects are limited to any defect which is a result of the manufacturing process. Excluded are holes, punctures, or other damages which can be caused during normal installation of a tent whenever proper procedures are not followed. Celina at its option will repair or replace this product or any component of product found to be defective during this warranty period. This warranty is valid for the original purchaser only, and is not transferable. This warranty does not cover normal wear or damage resulting from negligent use or misuse of the product, use contrary to instructions, repairs or alterations by anyone other than Celina, or forces of nature. Celina Tent is not responsible for methods that installers may choose to erect and secure the tent to the ground. Celina's responsibility is limited to the manufacture of the tent parts and materials.

This warranty is in lieu of all other warranties, and there are no warranties, expressed or implied, including warranties of merchantability of fitness for a particular purpose, which extend beyond the description on the face hereof. Celina Tent Inc. shall not be liable for any incidental or consequential damages. Some jurisdictions do not allow the exclusion of implied warranties or the imitation on incidental or consequential damages, so the above exclusions and limitations may not apply to you.

CALL BEFORE YOU DIG OR STAKE

| STATE | CENTER | PHONE |
|---------------|---|--------------|
| Alabama | Alabama Line Location | 800/292-8525 |
| Alaska | Locate Call Center of Alaska | 800/478-3121 |
| Arizona | Arizona Blue Stake | 800/782-5348 |
| Arkansas | Arkansas One Call System | 800/482-8998 |
| California | Underground Service Alert | 800/227-2600 |
| Colorado | Utility Notification Center of Colorado | 800/922-1987 |
| Connecticut | Call Before You Dig | 800/922-4455 |
| Delaware | Miss Utility of Delaware | 800/282-8555 |
| Florida | Call Sunshine | 800/432-4770 |
| Georgia | Utilities Protection Center | 800/282-7411 |
| Hawaii | Underground Service Alert North | 800/227-2600 |
| | Underground Service Alert South | 800/227-2600 |
| Idaho | Palouse Empire Underground | 800/822-1974 |
| | Utilities Underground Location Center | 800/424-5555 |
| | Dig Line | 800/342-1585 |
| | One Call Concepts - Idaho | 800/626-4950 |
| | Shoshone County One Call | 800/398-3285 |
| Illinois | Chicago Utility Alert Network | 800/892-0123 |
| Indiana | Indiana Underground Plant Protection | 800/382-5544 |
| Iowa | Underground Plant Location Service | 800/292-8989 |
| Kansas | Kansas One-Call Center | 800/344-7233 |
| Kentucky | Kentucky Underground Protection | 800/752-6007 |
| Louisiana | Louisiana One Call System | 800/272-3020 |
| Maine | Dig Safe - Maine | 888/344-7233 |
| Maryland | Miss Utility | 800/257-7777 |
| | Miss Utility of DESMARVA | 800/282-8555 |
| Massachusetts | Dig Safe-Massachusetts | 888/344-7233 |
| Michigan | Miss Dig System | 800/482-7171 |
| Minnesota | Gopher State One Call | 800/252-1166 |
| Mississippi | Mississippi One Call System | 800/227-6477 |
| Missouri | Missouri One Call System | 800/344-7483 |
| Montana | Utilities Underground Location Center | 800/424-5555 |
| | Montana U-Dig | 800/551-8344 |
| Nebraska | Diggers Hotline | 800/331-5666 |
| Nevada | Underground Service Alert North | 800/227-2600 |
| New Hampshire | Dig Safe-New Hampshire | 888/344-7233 |
| New Jersey | Garden State Underground | 800/272-1000 |
| New Mexico | New Mexico One Call System | 800/321-2537 |
| | Las Cruces-Dona Ana Utility Council | 888/526-0400 |

| STATE | CENTER | PHONE |
|----------------------|--------------------------------------|--------------|
| New York | Dig Safely New York | 800/926-7962 |
| | New York City-Long Island One Call | 800/272-4480 |
| North Carolina | North Carolina One Call | 800/634-4949 |
| North Dakota | North Dakota One Call | 800/795-0555 |
| Ohio | Ohio Utilities Protective Service | 800/362-2764 |
| | Oil & Gas Producers Underground | 800/925-2988 |
| Oklahoma | Call Okie | 800/522-6543 |
| Oregon | Oregon Utilities Notification Center | 800/332-2344 |
| Pennsylvania | Pennsylvania One Call System | 800/242-1776 |
| Rhode Island | Dig Safe-Rhode Island | 888/344-7233 |
| South Carolina | Palmetto Utility Protection Service | 800/922-0983 |
| South Dakota | South Dakota One Call | 800/781-7474 |
| Tennessee | Tennessee One-Call System | 800/351-1111 |
| Texas | Texas One Call System | 800/245-4545 |
| | Texas Excavation Safety System | 800/344-8377 |
| | Lone Star Notification System | 800/669-8344 |
| Utah | Blue Stakes Location Center | 800/622-4111 |
| Vermont | Dig Safe - Vermont | 888/344-7233 |
| Virginia | Miss Utility of Virginia | 800/552-7001 |
| | Miss Utility | 800/257-7777 |
| Washington | Miss Utility of DELMARVA | 800/441-8355 |
| | Notification Center | 800/424-5555 |
| | Utilities Council of Cowlitz County | 360/425-2506 |
| | Upper Yakima City Underground | 800/553-4344 |
| | Inland Empire Utility Coordinating | 509/456-8000 |
| West Virginia | Miss Utility of West Virginia | 800/245-4848 |
| Wisconsin | Diggers Hotline | 800/242-8511 |
| Wyoming | Wyoming One Call | 800/348-1030 |
| | Call Before you Dig Wyoming | 800/849-2476 |
| District of Columbia | Miss Utility | 800/257-7777 |
| Canada | Alberta One Call | 800/242-3447 |
| | Ontario | 800/400-2255 |
| | Info-Excavation (Quebec) | 800/663-9228 |
| | BC One Call | 800/474-6886 |
| | Manitoba - Winnipeg | 240/480-1212 |
| | Manitoba & Saskatchewan Safe | 800/827-5094 |

SUPPORT

For technical questions or replacement parts, please contact:

Celina Tent, Inc. / GetTent.com
 5373 State Route 29
 Celina, Ohio 45822-9210 USA

Telephone: 419-586-3610

Fax: 419-584-0949

Website: www.GetTent.com

Email: support@celinatent.com

YouTube: <http://www.youtube.com/user/celinatent>

Facebook: <http://www.facebook.com/celinatent>

Google +: <http://goo.gl/qvVdv>

Twitter: <http://twitter.com/celinatent>

LinkedIn: <http://www.linkedin.com/company/celina-tent-fabric-structures>